

## IRIS

~5° real spot beam optimized for CREE XP-E.  
Assembly with holder and installation tape.

### SPECIFICATION:

Dimensions	Ø 38.0 mm
Height	27.1 mm
Fastening	glue, tape, pin, screw
ROHS compliant	yes ⓘ



### MATERIALS:

Component	Type	Material	Colour	Finish
IRIS	Single lens	PMMA	clear	
IRIS-XP-HLD-TAPE	Assembly	PC	black	



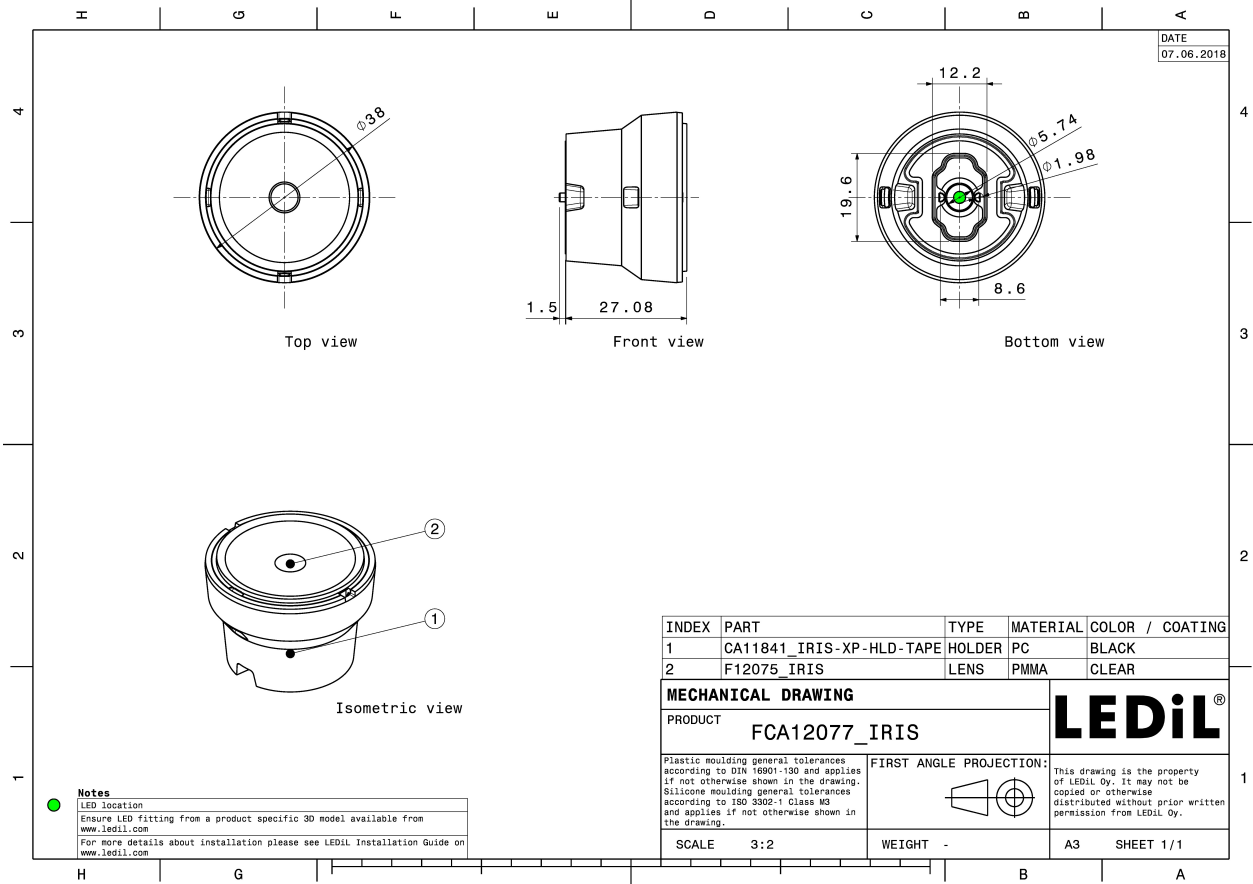

### ORDERING INFORMATION:

Component		Qty in box	MOQ	MPQ	Box weight (kg)
FCA12077_IRIS	Single lens	378	126	42	8.9
» Box size: 480 x 280 x 300 mm					

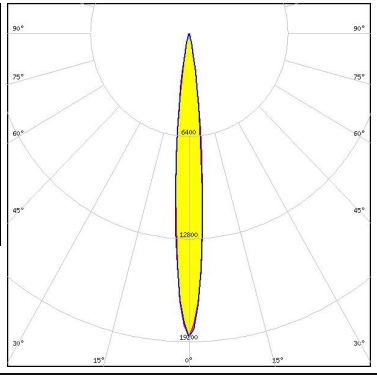

See also our general installation guide: [www.ledil.com/installation\\_guide](http://www.ledil.com/installation_guide)

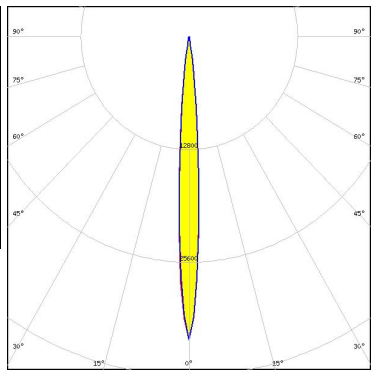
### OPTICAL RESULTS (MEASURED):

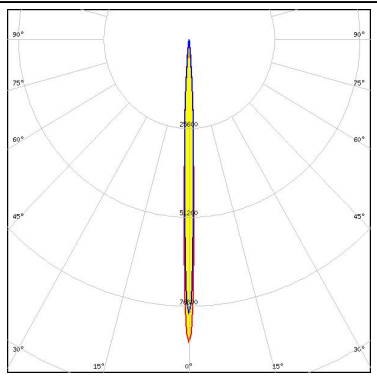
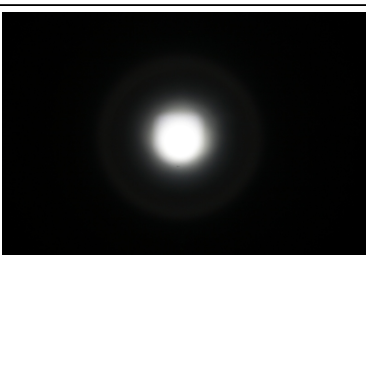
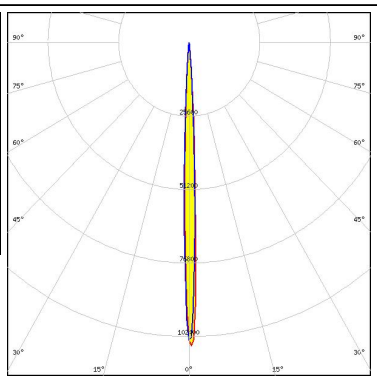
<p><b>CREE</b> → <b>LED</b></p> <p>LED XHP35 HD            FWHM / FWTM 10.0° / 23.0°            Efficiency 89 %            Peak intensity 18.6 cd/lm            LEDs/each optic 1            Light colour White            Required components:</p>		
<p><b>CREE</b> → <b>LED</b></p> <p>LED XHP35 HI            FWHM / FWTM 7.6° / 17.0°            Efficiency 90 %            Peak intensity 35.9 cd/lm            LEDs/each optic 1            Light colour White            Required components:</p>		
<p><b>CREE</b> → <b>LED</b></p> <p>LED XP-E            FWHM / FWTM 4.0° / 9.0°            Efficiency 93 %            Peak intensity 87.4 cd/lm            LEDs/each optic 1            Light colour White            Required components:</p>		
<p><b>CREE</b> → <b>LED</b></p> <p>LED XP-E2            FWHM / FWTM 5.0° / 9.0°            Efficiency 93 %            Peak intensity 103.9 cd/lm            LEDs/each optic 1            Light colour White            Required components:</p>		

#### OPTICAL RESULTS (MEASURED):

##### CREE LED

LED XP-G  
 FWHM / FWTM 6.0° / 14.0°  
 Efficiency 94 %  
 Peak intensity 46.4 cd/lm  
 LEDs/each optic 1  
 Light colour White  
 Required components:

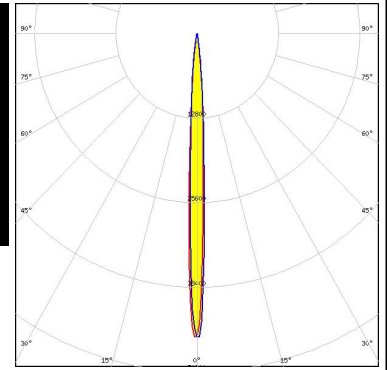
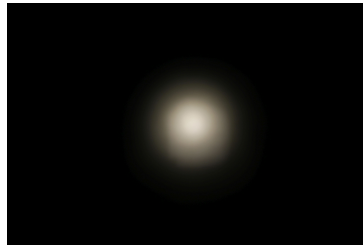

##### CREE LED

LED XP-G2  
 FWHM / FWTM 6.0° / 14.0°  
 Efficiency 95 %  
 Peak intensity 46 cd/lm  
 LEDs/each optic 1  
 Light colour White  
 Required components:

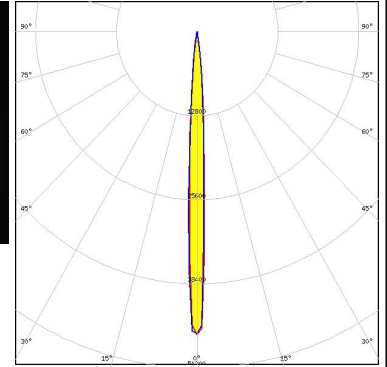
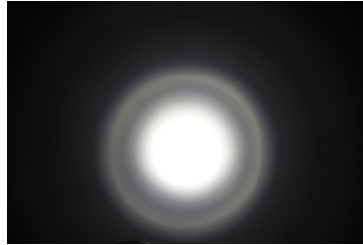

##### CREE LED

LED XP-P  
 FWHM / FWTM 3.0° / 8.0°  
 Efficiency 96 %  
 Peak intensity 152.7 cd/lm  
 LEDs/each optic 1  
 Light colour White  
 Required components:

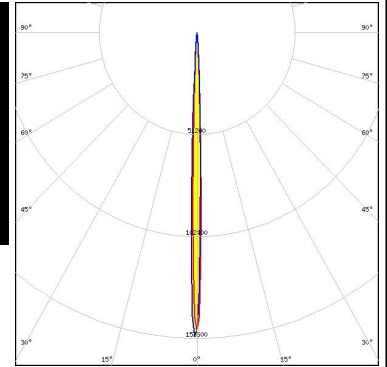
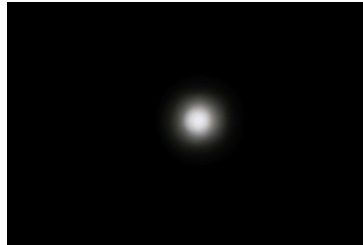

##### CREE LED

LED XQ-E HI  
 FWHM / FWTM 3.9° / 9.0°  
 Efficiency 88 %  
 Peak intensity 123.3 cd/lm  
 LEDs/each optic 1  
 Light colour White  
 Required components:

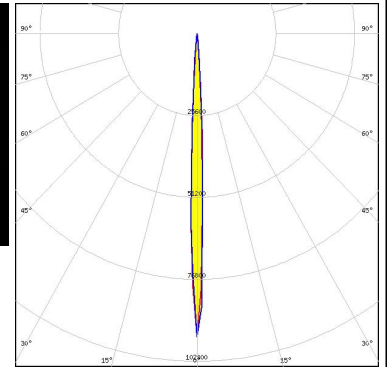
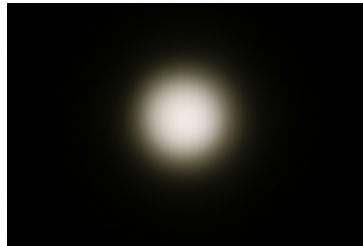



#### OPTICAL RESULTS (MEASURED):



LED XT-E  
 FWHM / FWTM 6.0° / 13.0°  
 Efficiency 91 %  
 Peak intensity 44 cd/lm  
 LEDs/each optic 1  
 Light colour White  
 Required components:

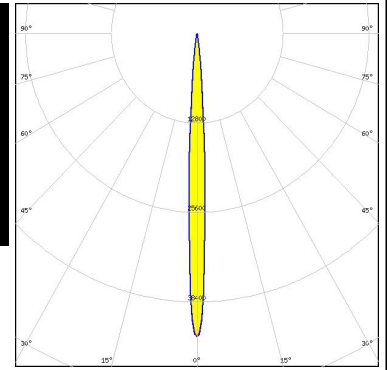
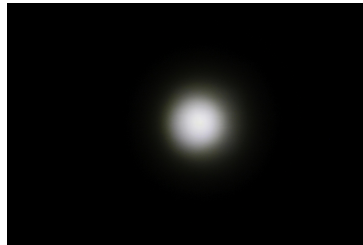

LED LUXEON Rebel  
 FWHM / FWTM 5.0° / 9.0°  
 Efficiency %  
 Peak intensity 75.6 cd/lm  
 LEDs/each optic 1  
 Light colour White  
 Required components:

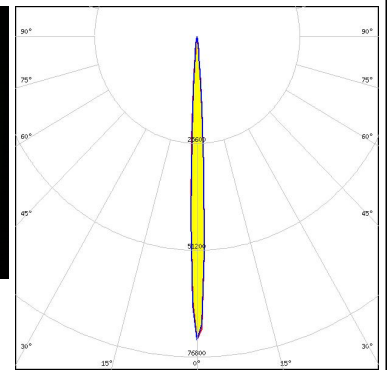

LED LUXEON Rebel ES  
 FWHM / FWTM 7.0° / 14.0°  
 Efficiency 93 %  
 Peak intensity 38.5 cd/lm  
 LEDs/each optic 1  
 Light colour White  
 Required components:

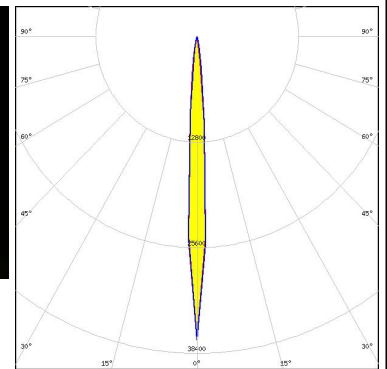

LED LUXEON T  
 FWHM / FWTM 7.0° / 14.0°  
 Efficiency 94 %  
 Peak intensity 40.2 cd/lm  
 LEDs/each optic 1  
 Light colour White  
 Required components:

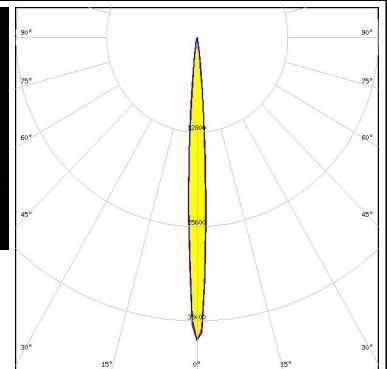

### OPTICAL RESULTS (MEASURED):

#### LUMILEDS

LED LUXEON TX  
 FWHM / FWTM 6.9° / 15.0°  
 Efficiency 89 %  
 Peak intensity 43.1 cd/lm  
 LEDs/each optic 1  
 Light colour White  
 Required components:

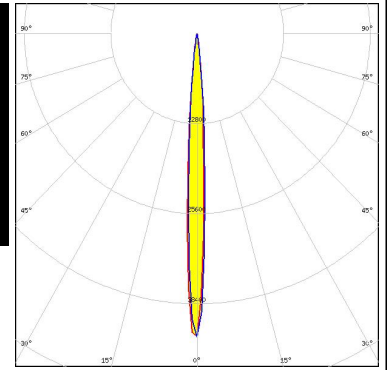

#### LUMILEDS

LED LUXEON Z ES  
 FWHM / FWTM 4.0° / 9.0°  
 Efficiency 93 %  
 Peak intensity 94.1 cd/lm  
 LEDs/each optic 1  
 Light colour White  
 Required components:

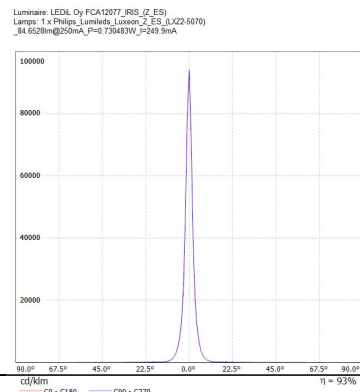

#### NICHIA

LED NCSxx19A  
 FWHM / FWTM 5.0° / 11.0°  
 Efficiency %  
 LEDs/each optic 1  
 Light colour White  
 Required components:

#### NICHIA

LED NVSW219F  
 FWHM / FWTM 7.0° / 16.0°  
 Efficiency 94 %  
 Peak intensity 35.7 cd/lm  
 LEDs/each optic 1  
 Light colour White  
 Required components:

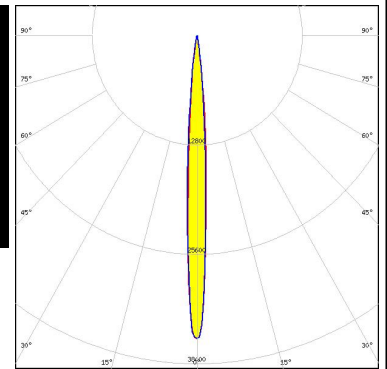
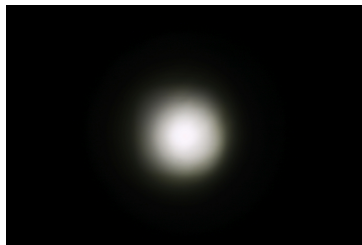

### OPTICAL RESULTS (MEASURED):



LED NVSW3x9A  
FWHM / FWTM 8.0° / 18.0°  
Efficiency 89 %  
Peak intensity 26.3 cd/lm  
LEDs/each optic 1  
Light colour White  
Required components:

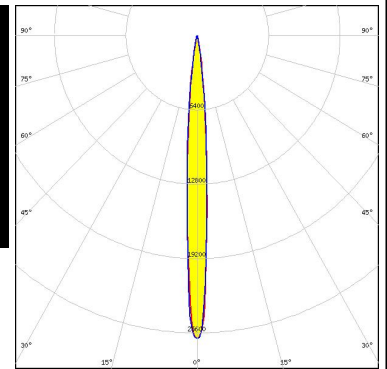

LED NVSW719AC  
FWHM / FWTM 7.0° / 11.0°  
Efficiency 91 %  
Peak intensity 55.9 cd/lm  
LEDs/each optic 1  
Light colour White  
Required components:

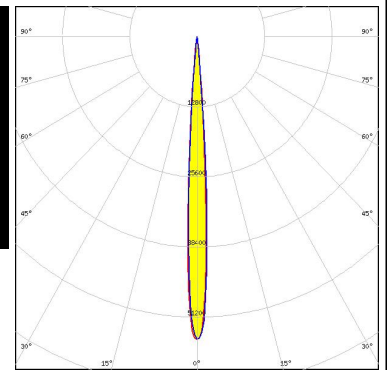





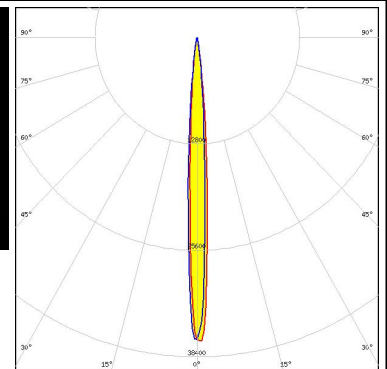

LED NVSxx19A  
FWHM / FWTM 6.0° / 14.0°  
Efficiency 93 %  
Peak intensity 38.7 cd/lm  
LEDs/each optic 1  
Light colour White  
Required components:

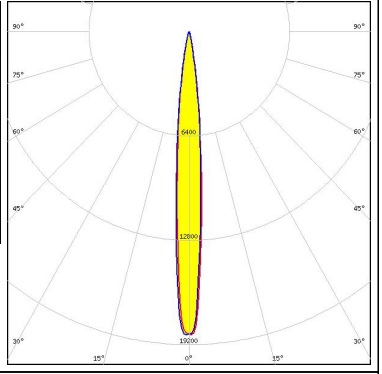

LED NVSxx19B/NVSxx19C  
FWHM / FWTM 7.0° / 15.0°  
Efficiency 92 %  
Peak intensity 36.6 cd/lm  
LEDs/each optic 1  
Light colour White  
Required components:

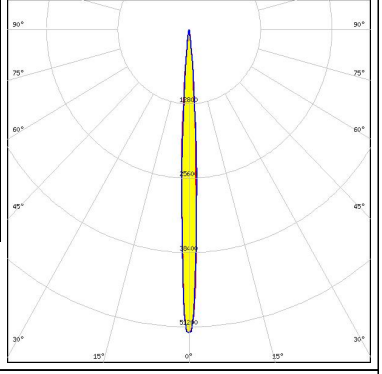

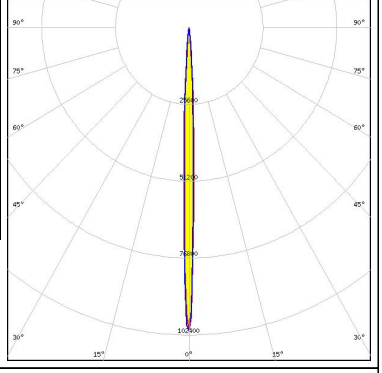
### OPTICAL RESULTS (MEASURED):

<p><b>NICHIA</b></p> <p>LED NWSx229A            FWHM / FWTM 10.0° / 21.0°            Efficiency 91 %            Peak intensity 18.6 cd/lm            LEDs/each optic 1            Light colour White            Required components:</p>		
<p><b>OSRAM</b> Opto Semiconductors</p> <p>LED OSLON Square EC            FWHM / FWTM 6.0° / 12.0°            Efficiency 92 %            Peak intensity 52 cd/lm            LEDs/each optic 1            Light colour White            Required components:</p>		
<p><b>OSRAM</b> Opto Semiconductors</p> <p>LED OSLON SSL 150            FWHM / FWTM 4.0° / 9.0°            Efficiency 94 %            Peak intensity 101 cd/lm            LEDs/each optic 1            Light colour White            Required components:</p>		
<p><b>OSRAM</b> Opto Semiconductors</p> <p>LED OSLON SSL 80            FWHM / FWTM 4.0° / 9.0°            Efficiency 90 %            Peak intensity 89 cd/lm            LEDs/each optic 1            Light colour White            Required components:</p>		

**OPTICAL RESULTS (MEASURED):**

**SAMSUNG**

LED LH351Z  
 FWHM / FWTM 7.0° / 15.0°  
 Efficiency 89 %  
 Peak intensity 48.1 cd/lm  
 LEDs/each optic 1  
 Light colour White  
 Required components:

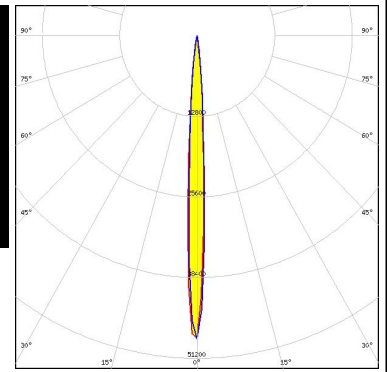

SEOUL SEMICONDUCTOR  
 LED Z5M3  
 FWHM / FWTM 7.0° / 16.0°  
 Efficiency 92 %  
 Peak intensity 30 cd/lm  
 LEDs/each optic 1  
 Light colour White  
 Required components:

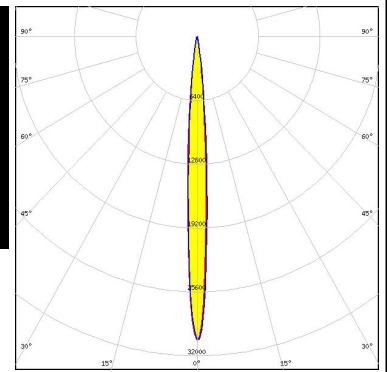
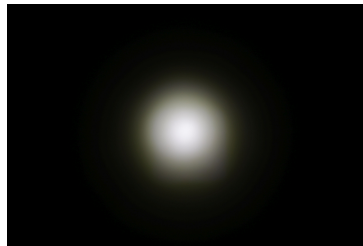

### OPTICAL RESULTS (SIMULATED):

#### CREE LED

LED XD16  
 FWHM / FWTM 6.0° / 14.0°  
 Efficiency 91 %  
 Peak intensity 47.9 cd/lm  
 LEDs/each optic 1  
 Light colour White  
 Required components:

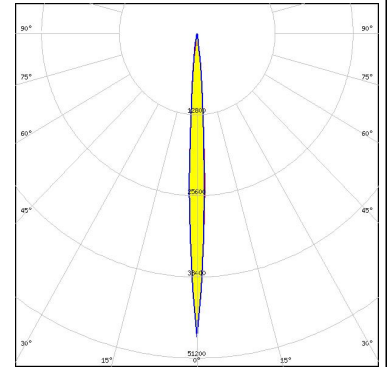

#### CREE LED

LED XE-G  
 FWHM / FWTM 4.0° / 10.0°  
 Efficiency 91 %  
 Peak intensity 87.9 cd/lm  
 LEDs/each optic 1  
 Light colour White  
 Required components:

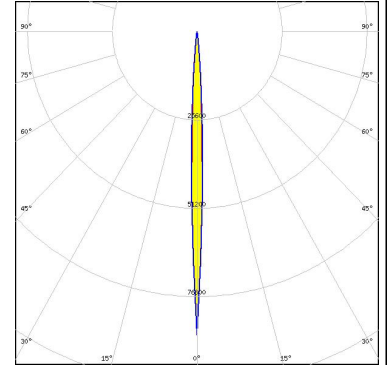

#### CREE LED

LED XP-G2 HE  
 FWHM / FWTM 8.0° / 18.0°  
 Efficiency 92 %  
 Peak intensity 29.7 cd/lm  
 LEDs/each optic 1  
 Light colour White  
 Required components:

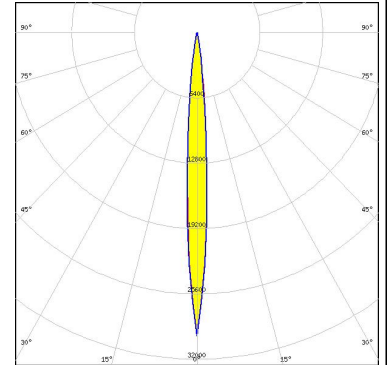

#### CREE LED

LED XP-G3  
 FWHM / FWTM 7.7° / 18.0°  
 Efficiency 91 %  
 Peak intensity 28.7 cd/lm  
 LEDs/each optic 1  
 Light colour White  
 Required components:

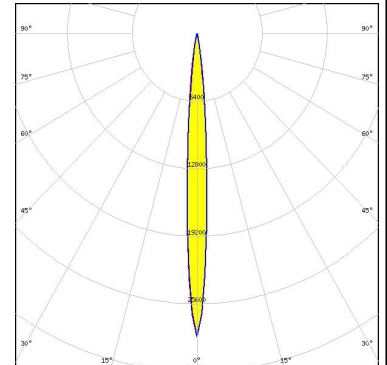

#### OPTICAL RESULTS (SIMULATED):



LED XP-L HD  
 FWHM / FWTM 8.6° / 19.0°  
 Efficiency 93 %  
 Peak intensity 25.3 cd/lm  
 LEDs/each optic 1  
 Light colour White  
 Required components:

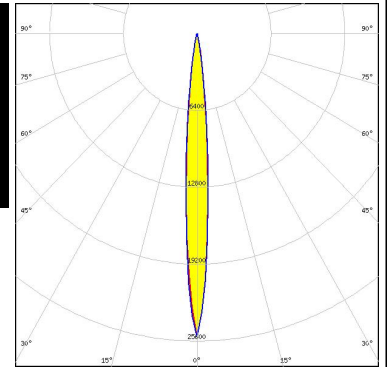

LED XQ-E HD  
 FWHM / FWTM 5.0° / 11.5°  
 Efficiency 93 %  
 Peak intensity 80 cd/lm  
 LEDs/each optic 1  
 Light colour White  
 Required components:

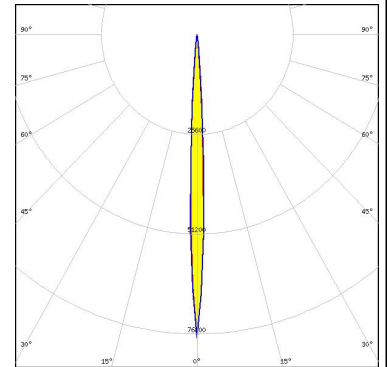

LED XQ-E HD  
 FWHM / FWTM 5.3° / 11.0°  
 Efficiency 94 %  
 Peak intensity 77.8 cd/lm  
 LEDs/each optic 1  
 Light colour White  
 Required components:

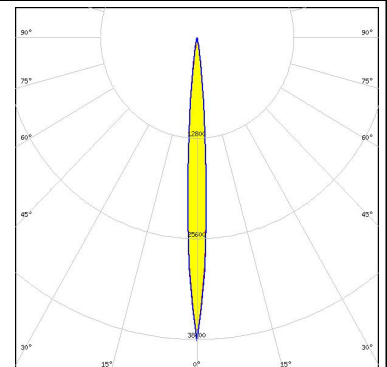

LED LUXEON H50-2  
 FWHM / FWTM 7.0° / 15.0°  
 Efficiency 94 %  
 Peak intensity 38.6 cd/lm  
 LEDs/each optic 1  
 Light colour White  
 Required components:



### OPTICAL RESULTS (SIMULATED):

#### LUMILEDS

LED LUXEON SunPlus 20 Line (150 deg)  
 FWHM / FWTM 6.0° / 14.0°  
 Efficiency 90 %  
 Peak intensity 42.7 cd/lm  
 LEDs/each optic 1  
 Light colour White  
 Required components:

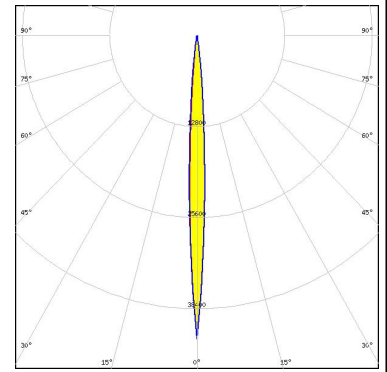

#### LUMILEDS

LED LUXEON SunPlus 35 Line  
 FWHM / FWTM 6.0° / 15.0°  
 Efficiency 94 %  
 Peak intensity 49.9 cd/lm  
 LEDs/each optic 1  
 Light colour Blue  
 Required components:

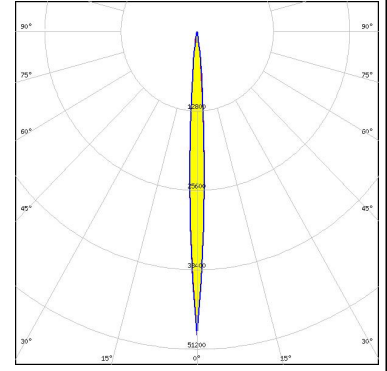

#### LUMINUS

LED SST-10-B130  
 FWHM / FWTM 6.0° / 13.0°  
 Efficiency 94 %  
 LEDs/each optic 1  
 Light colour IR  
 Required components:

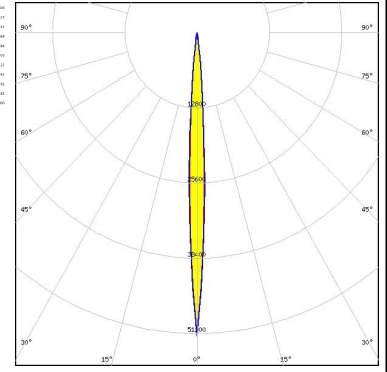
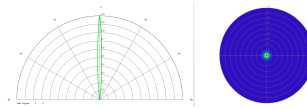

#### LUMINUS

LED SST-20  
 FWHM / FWTM 6.0° / 14.0°  
 Efficiency 93 %  
 Peak intensity 48.4 cd/lm  
 LEDs/each optic 1  
 Light colour White  
 Required components:

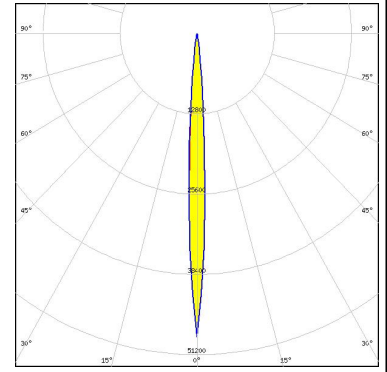

#### OPTICAL RESULTS (SIMULATED):

<p><b>OSRAM</b> Opto Semiconductors</p> <p>LED Duris S5 (Single chip)</p> <p>FWHM / FWTM 6.0° / 14.0°</p> <p>Efficiency 94 %</p> <p>Peak intensity 48.2 cd/lm</p> <p>LEDs/each optic 1</p> <p>Light colour Yellow</p> <p>Required components:</p>	
<p><b>OSRAM</b> Opto Semiconductors</p> <p>LED Duris S5 (Single chip)</p> <p>FWHM / FWTM 4.0° / 12.0°</p> <p>Efficiency 93 %</p> <p>Peak intensity 72.5 cd/lm</p> <p>LEDs/each optic 1</p> <p>Light colour Green</p> <p>Required components:</p>	
<p><b>OSRAM</b> Opto Semiconductors</p> <p>LED Duris S5 (Single chip)</p> <p>FWHM / FWTM 4.0° / 12.0°</p> <p>Efficiency 93 %</p> <p>Peak intensity 74.7 cd/lm</p> <p>LEDs/each optic 1</p> <p>Light colour Red</p> <p>Required components:</p>	
<p><b>OSRAM</b> Opto Semiconductors</p> <p>LED OSCONIQ P 3737 (2W version)</p> <p>FWHM / FWTM 6.0° / 14.0°</p> <p>Efficiency 94 %</p> <p>Peak intensity 46.2 cd/lm</p> <p>LEDs/each optic 1</p> <p>Light colour White</p> <p>Required components:</p>	

#### OPTICAL RESULTS (SIMULATED):

<p><b>OSRAM</b> Opto Semiconductors</p> <p>LED OSLON Black Flat (LUW HWQP)</p> <p>FWHM / FWTM 6.0° / 14.0°</p> <p>Efficiency 94 %</p> <p>Peak intensity 48.9 cd/lm</p> <p>LEDs/each optic 1</p> <p>Light colour White</p> <p>Required components:</p>	
<p><b>OSRAM</b> Opto Semiconductors</p> <p>LED OSLON Black Flat (LUW HWQP)</p> <p>FWHM / FWTM 4.2° / 10.0°</p> <p>Efficiency 94 %</p> <p>Peak intensity 92 cd/lm</p> <p>LEDs/each optic 1</p> <p>Light colour White</p> <p>Required components:</p>	
<p><b>OSRAM</b> Opto Semiconductors</p> <p>LED OSLON Square CSSRM2/CSSRM3</p> <p>FWHM / FWTM 6.4° / 14.0°</p> <p>Efficiency 94 %</p> <p>Peak intensity 48.3 cd/lm</p> <p>LEDs/each optic 1</p> <p>Light colour White</p> <p>Required components:</p>	
<p><b>OSRAM</b> Opto Semiconductors</p> <p>LED OSTAR Projection Compact (KW.CSLNM1.TG)</p> <p>FWHM / FWTM 6.0° / 12.0°</p> <p>Efficiency 94 %</p> <p>Peak intensity 76.4 cd/lm</p> <p>LEDs/each optic 1</p> <p>Light colour White</p> <p>Required components:</p>	

#### OPTICAL RESULTS (SIMULATED):

#### OSRAM

Opto Semiconductors

LED OSTAR Projection Compact (KW.CSLNM1.TG)  
 FWHM / FWTM 4.0° / 10.0°  
 Efficiency 93 %  
 Peak intensity 94.8 cd/lm  
 LEDs/each optic 1  
 Light colour White  
 Required components:

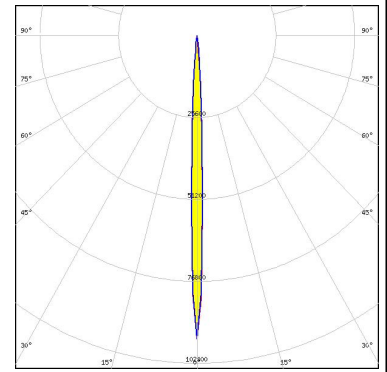

#### OSRAM

Opto Semiconductors

LED SFH 4716AS  
 FWHM / FWTM 6.0° / 12.0°  
 Efficiency 94 %  
 LEDs/each optic 1  
 Light colour IR  
 Required components:

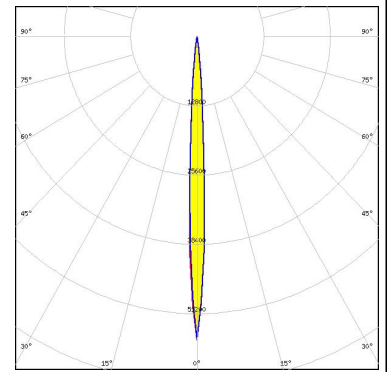

#### SAMSUNG

LED LH351C  
 FWHM / FWTM 8.0° / 18.0°  
 Efficiency 93 %  
 Peak intensity 31.2 cd/lm  
 LEDs/each optic 1  
 Light colour White  
 Required components:

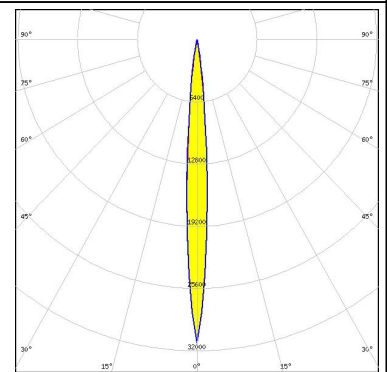

#### SAMSUNG

LED LH351D  
 FWHM / FWTM 9.3° / 21.0°  
 Efficiency 90 %  
 Peak intensity 21 cd/lm  
 LEDs/each optic 1  
 Light colour White  
 Required components:

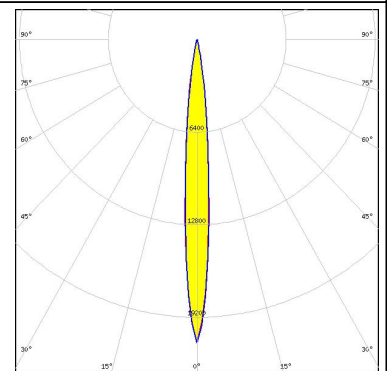

### OPTICAL RESULTS (SIMULATED):



### GENERAL INFORMATION:

NOTE: The typical beam angle will be changed by different color, chip size and chip position tolerance. The typical total beam angle is the full angle measured where the luminous intensity is half of the peak value.

### MATERIALS:

As part of our continuous research and improvement processes, and to ensure the best possible quality and availability of our products, LEDiL reserves the right to change material grades without notice.

### PRODUCT DATA USER AGREEMENT AND DISCLAIMER:

The measured data in the provided downloadable LEDiL Product Datasheets and Mechanical 2D-Drawings is rounded and provided as reference for planning. LEDiL Oy's optical specifications have been verified by conducting performance testing of the products in accordance with the company's quality system. The reported data are averaged results of multiple measurements with typical variation. LEDiL Oy reserves the right to without prior notification make changes and improvements to its products.

LEDiL Oy assumes neither warranty, nor guarantee nor any other liability of any kind for the contents and correctness of the provided data. The provided data has been generated with highest diligence but the provided data may in reality not represent the complete possible variation range of all intrinsic parameters. Therefore, in certain cases a deviation from the provided data could occur.

LEDiL Oy reserves the right to undertake technical changes of its products without further notification which could lead to changes in the provided data. LEDiL Oy assumes no liability of any kind for the possible deviation from any provided data or any other damage resulting from the usage of the provided data.

The user agrees to this disclaimer and user agreement with the download or usage of the provided files.

#### LEDiL Oy

Joensuunkatu 13  
FI-24240 SALO  
Finland

#### LEDiL Inc.

228 West Page Street  
Suite D  
Sycamore IL 60178  
USA

#### Ledil Optics Technology (Shenzhen) Co., Ltd.

# 405 , Block B  
Casic Motor Building  
Shenzhen 518057  
P.R.CHINA

#### Local sales and technical support

[www.ledil.com/  
where\\_to\\_buy](http://www.ledil.com/where_to_buy)

#### Shipping locations

Salo, Finland  
Hong Kong, China

#### Distribution Partners

[www.ledil.com/  
where\\_to\\_buy](http://www.ledil.com/where_to_buy)