



# American Opto Plus LED Corp.

## IRP4-850C-45D

3.9 x 3.9 x 2.9mm High Power IR LED

### PACKAGE OUTLINES

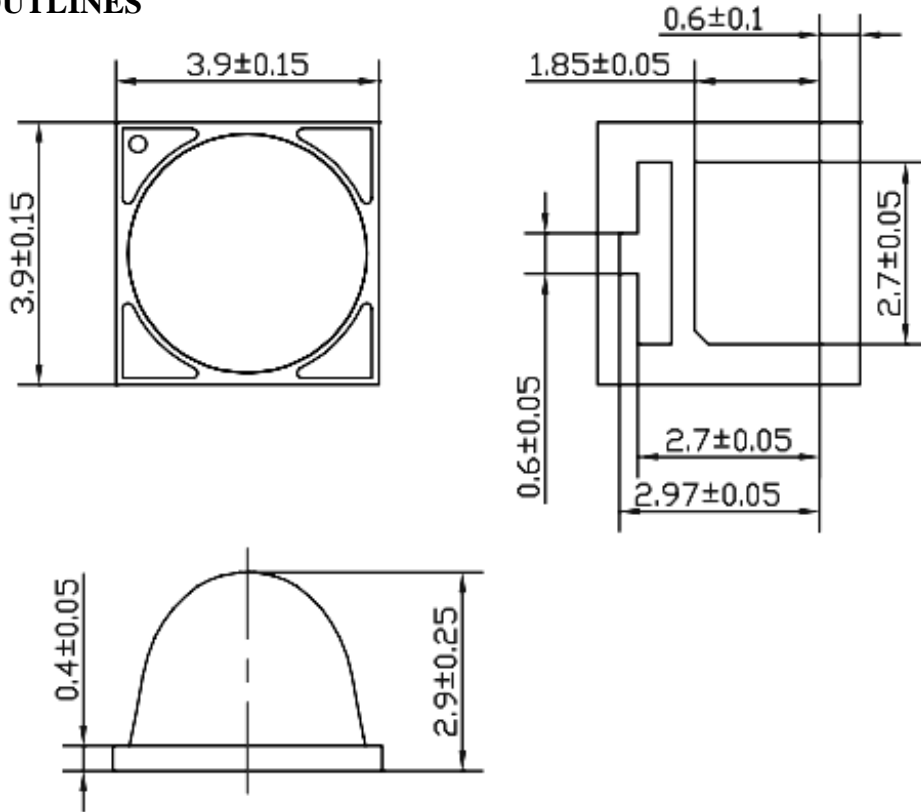

### FEATURES

1. Dimension: 3.9mm(L)×3.9mm(W).
2. High Radiant Flux type.
3. All Metal Design Cu Substrate with Silicone Lens.
4. Narrow beam angle 45°.
5. Ultra-low thermal resistance.
6. MSL Level: 3.
7. 30Mil Die

### Note:

1. Units are in millimeters.



# American Opto Plus LED Corp.

## IRP4-850C-45D

3.9 x 3.9 x 2.9mm High Power IR LED

### PAD CONFIGURATION

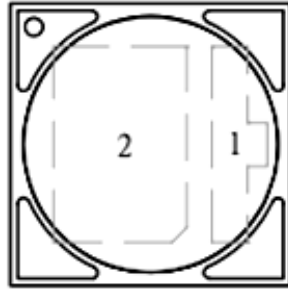

TOP

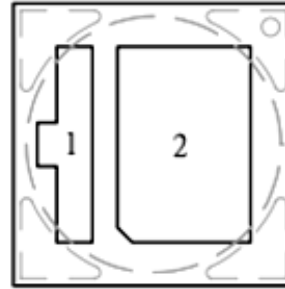

BOTTOM

Pad	Function
1	Cathode
2	Anode, Thermal

Note:

1. Please do not put conductive material on the top surface of the LEDs.



# American Opto Plus LED Corp.

## IRP4-850C-45D

3.9 x 3.9 x 2.9mm High Power IR LED

### ABSOLUTE MAXIMUM RATINGS

T<sub>j</sub>=25°C

Parameter	Symbol	Rating	Unit
Power Dissipation	P	2.5	W
Forward Current	I <sub>F</sub>	1000	mA
Reverse Voltage	V <sub>R</sub>	5	V
LED Junction Temperature	T <sub>j</sub>	125	°C
Operating Temp. Range	T <sub>opr</sub>	-40°C~+85°C	
Storage Temp. Range	T <sub>stg</sub>	-40°C~+120°C	
Soldering Condition	T <sub>sol</sub>	260°C for 10 sec.	

### ELECTRICAL/OPTICAL CHARACTERISTICS

T<sub>j</sub>=25°C

Parameter	Symbol	Min	Typ	Max	Test Condition	Unit
Peak Wavelength	λ <sub>p</sub>	840	850	870	IF=1000mA	nm
Radiant Flux	Φ <sub>e</sub>	600	750	--		mW
Radiant Intensity	I <sub>e</sub>	--	680	--		mW/Sr
Forward Voltage	V <sub>F</sub>	1.6	1.8	2.1		V
Spectral Half-Width	Δλ	--	40	--		nm
Beam Angle	2θ ½	--	45	--		deg
Temp. Coefficient of Brightness	TC <sub>I</sub>	--	-0.3	--	--	%/K
Temp. Coefficient of Voltage	TC <sub>V</sub>	--	-1	--	--	mV/K
Temp. Coefficient of Wavelength	TC <sub>λ</sub>	--	0.3	--	--	nm/K
Thermal Resistance, Junction Case	R <sub>th, J-C1</sub>	--	5	--	--	°C/W

The thermal resistance value is measured with MCPCB (star).



# American Opto Plus LED Corp.

## IRP4-850C-45D

3.9 x 3.9 x 2.9mm High Power IR LED

### BIN CODE LIST

T<sub>j</sub>=25°C

Item	Bin Code	Symbol	Condition	Min	Max	Unit
Forward Voltage	B	VF	IF=1000mA	1.59	1.83	V
	C			1.83	2.07	
Radiant Flux	G	Φ <sub>e</sub>		600	700	mW
	H			700	800	
	J			800	900	

Forward voltage measurement allowance is  $\pm 0.1V$ .

Radiant flux measurement allowance is  $\pm 10\%$ .



# American Opto Plus LED Corp.

## IRP4-850C-45D

3.9 x 3.9 x 2.9mm High Power IR LED

### CHARACTERISTIC DIAGRAMS

Forward Current vs. Forward Voltage

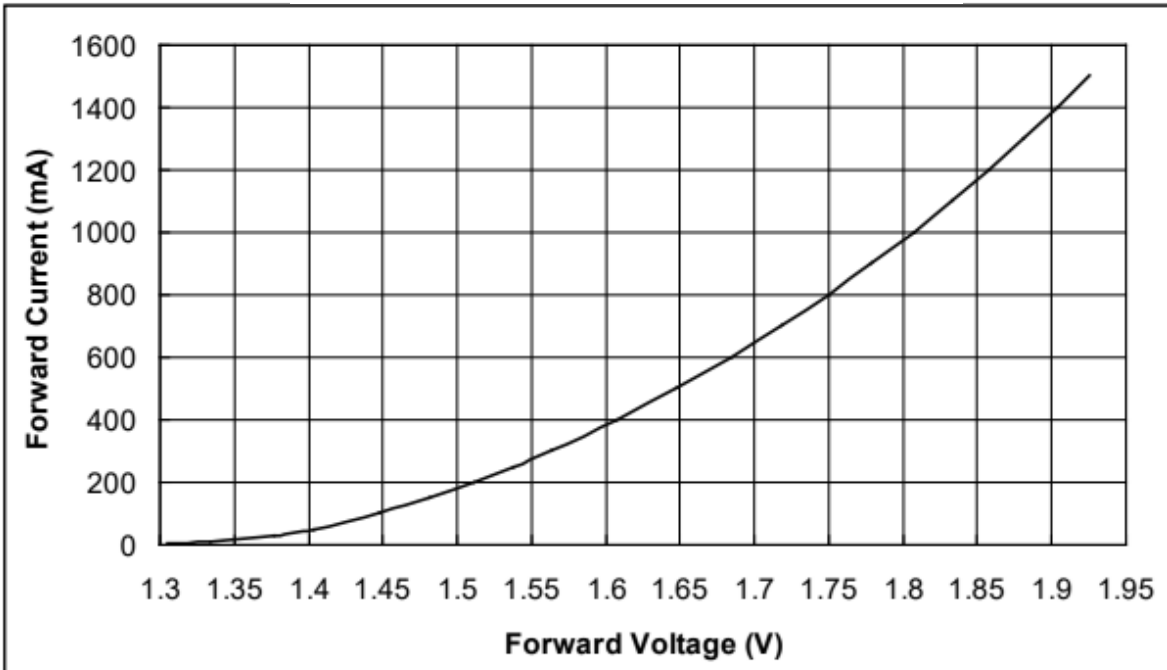

Relative Intensity vs. Forward Current

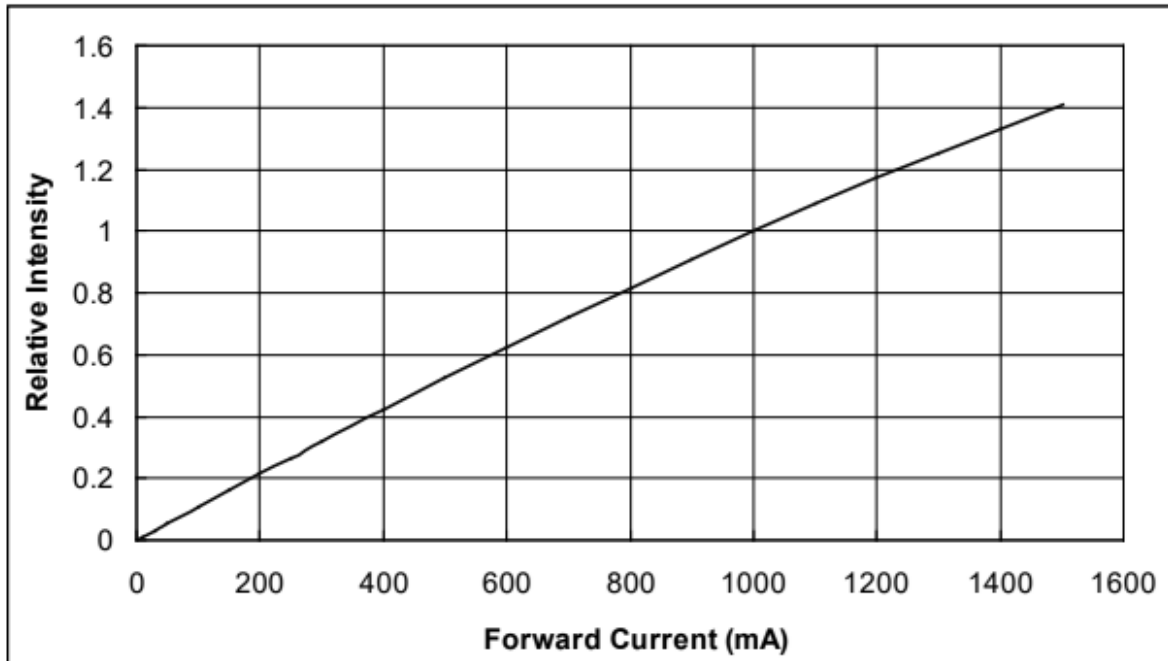



# American Opto Plus LED Corp.

## IRP4-850C-45D

3.9 x 3.9 x 2.9mm High Power IR LED

### CHARACTERISTIC DIAGRAMS

Typical Relative Intensity vs. wavelength

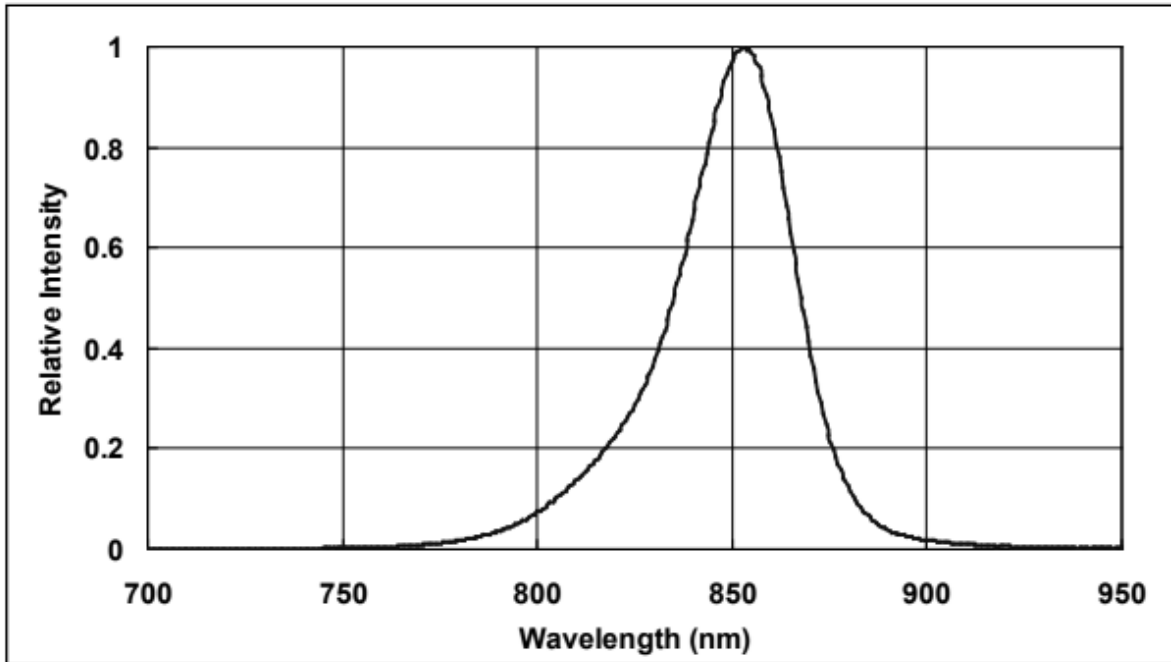

Typical Representative Spatial Radiation Pattern

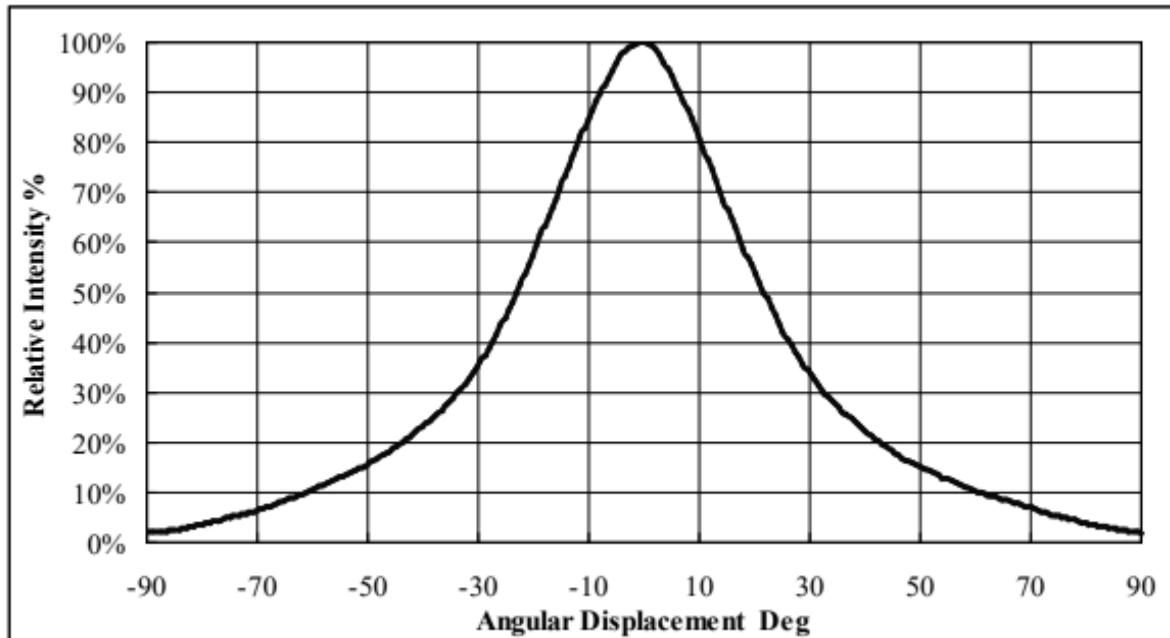



# American Opto Plus LED Corp.

## IRP4-850C-45D

3.9 x 3.9 x 2.9mm High Power IR LED

### CHARACTERISTIC DIAGRAMS

Permissible pulse handling capability at  $T_j=85^\circ\text{C}$  for various duty cycles (D)

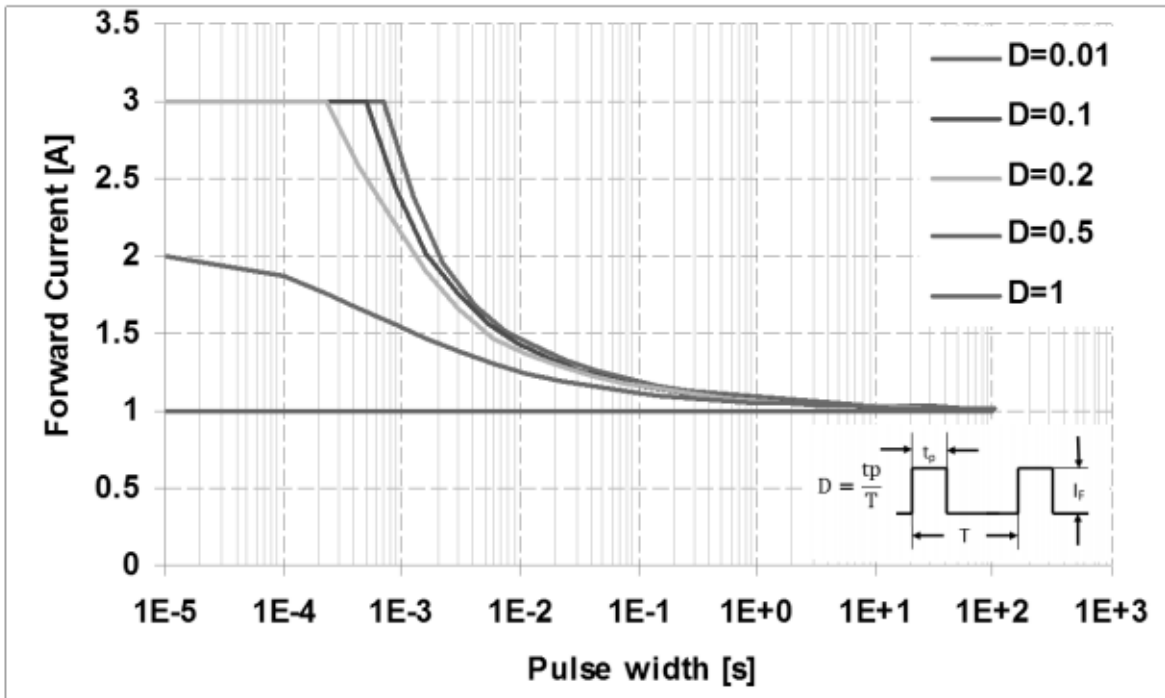



# American Opto Plus LED Corp.

## IRP4-850C-45D

3.9 x 3.9 x 2.9mm High Power IR LED

### PACKAGING SPECIFICATIONS

#### Taping Dimensions

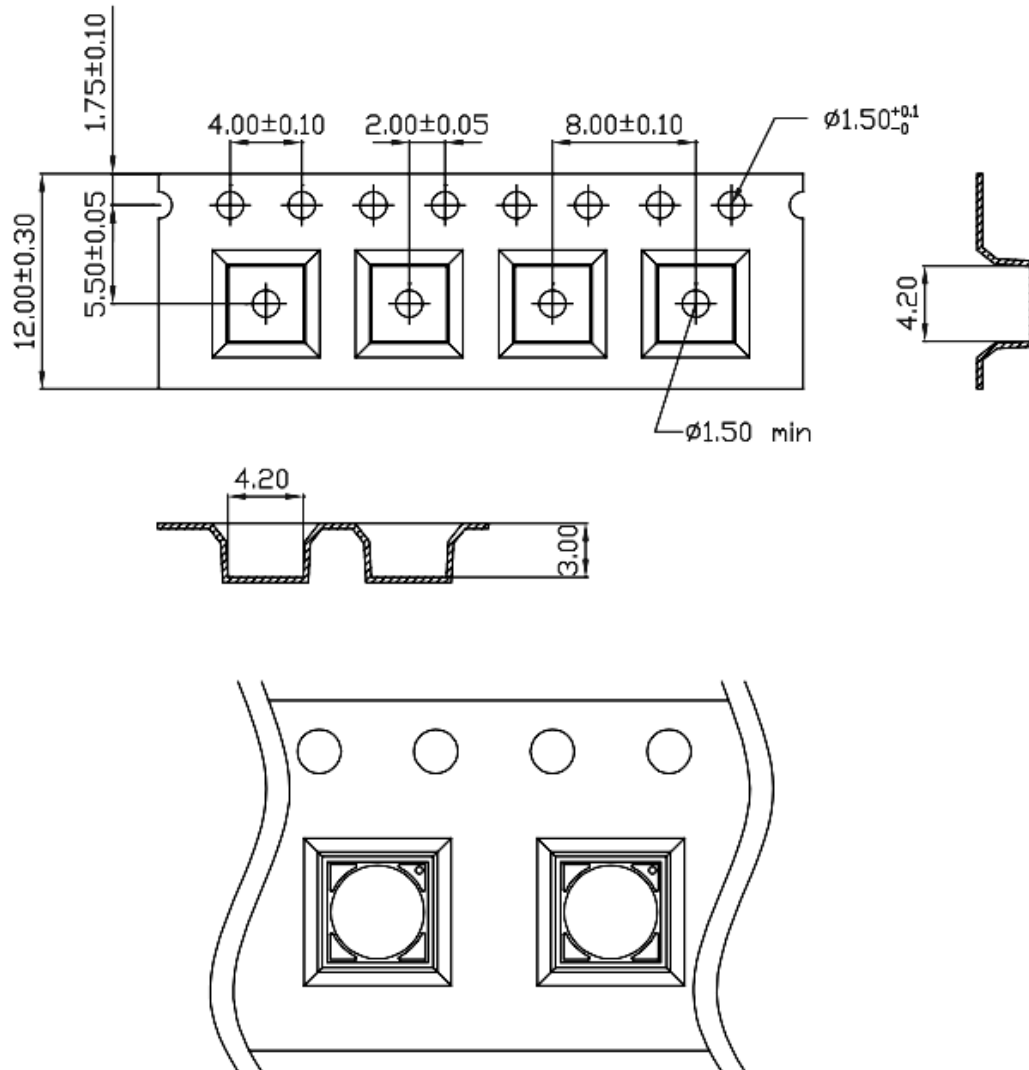

Note:

1. 1 Reel/bag.
2. 2500pcs/reel.
3. Units are in millimeters.





# American Opto Plus LED Corp.

## IRP4-850C-45D

3.9 x 3.9 x 2.9mm High Power IR LED

### PACKAGE SPECIFICATIONS

Reel Dimensions (Unit: mm)

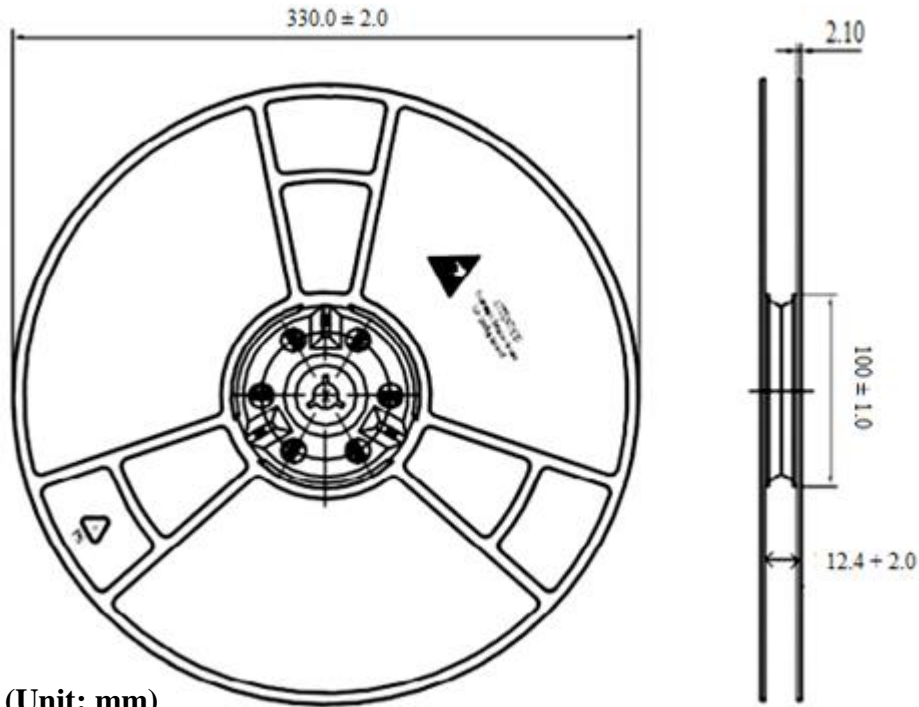

Anti-Statistic Bag (Unit: mm)

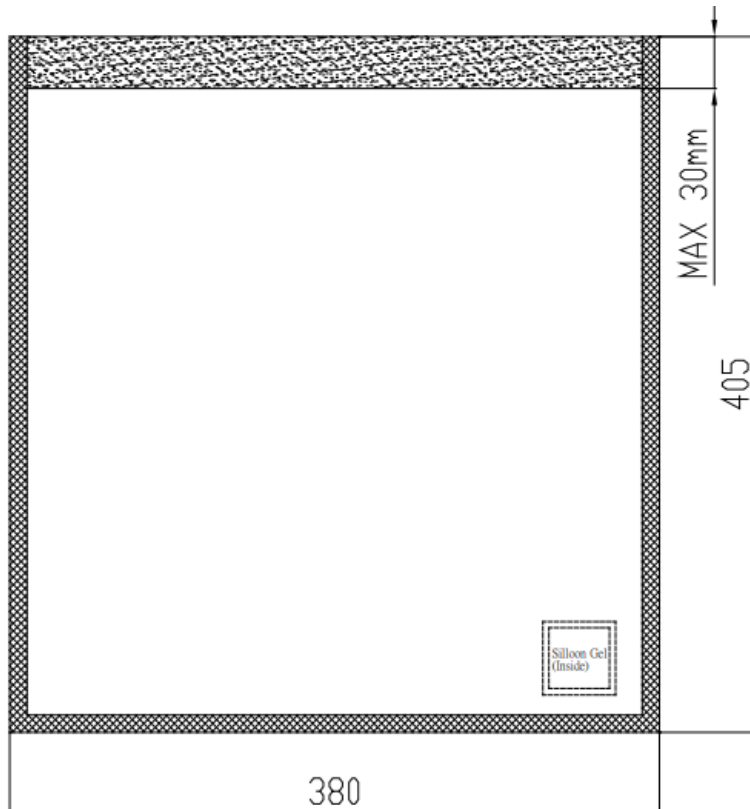



# American Opto Plus LED Corp.

## IRP4-850C-45D

3.9 x 3.9 x 2.9mm High Power IR LED

### QUALIFICATION RELIABILITY TESTING

Classification	Test Item	Test Conditions	Reference Standard
Endurance Test	Operation Life	IF = 1000mA Ta = 25°C Test Duration = 1000hrs	MIL – STD – 750: 1026 MIL – STD – 883: 1005 JIS C 7021: B-1
	High Temp. High Humidity Storage	Ta = 85 ± 5°C RH = 85 ± 5% Test Duration = 1000hrs	MIL – STD – 202: 103B JIS C 7021: B-11
	High Temperature Storage	Ta = 105 ± 5°C Test Duration = 1000hrs	MIL – STD – 202: 1008 JIS C 7021: B-10
	Low Temperature Storage	Ta = -40 ± 5°C Test Duration = 1000hrs	JIS C 7021: B-12
Environmental Test	Temperature Cycling	-30°C ~ 25°C ~ 105°C ~ 25°C 30min – 5min – 30min – 5 min Test Duration = 10 cycles	MIL-STD-202: 107D MIL-STD-750: 1051 MIL-STD-883: 1010 JIS C 7021: A-4
	Thermal Shock	-30 ± 5°C ~ 105 ± 5°C 30min ~ 30min Test Duration = 10 cycles	MIL-STD-202: 107D MIL-STD-750: 1051 MIL-STD-883: 1011
	Solder Resistance	Tsol = 260 ± 5°C Dwell Time: 10	MIL-STD-202: 210A MIL-STD-750: 2031



# American Opto Plus LED Corp.

## IRP4-850C-45D

3.9 x 3.9 x 2.9mm High Power IR LED

		sec	JIS C 7021: A-1
--	--	-----	-----------------

### RELIABILITY TESTING

Measuring Items	Symbol	Measuring Conditions	Failure Criteria
Forward Voltage	V <sub>F</sub>	I <sub>F</sub> =1000mA	V <sub>F</sub> shift > 10%
Luminous	I <sub>v</sub> %	I <sub>F</sub> =1000mA	I <sub>v</sub> % shift > 10%



# American Opto Plus LED Corp.

## IRP4-850C-45D

3.9 x 3.9 x 2.9mm High Power IR LED

### RECOMMENDED SOLDER PROFILE

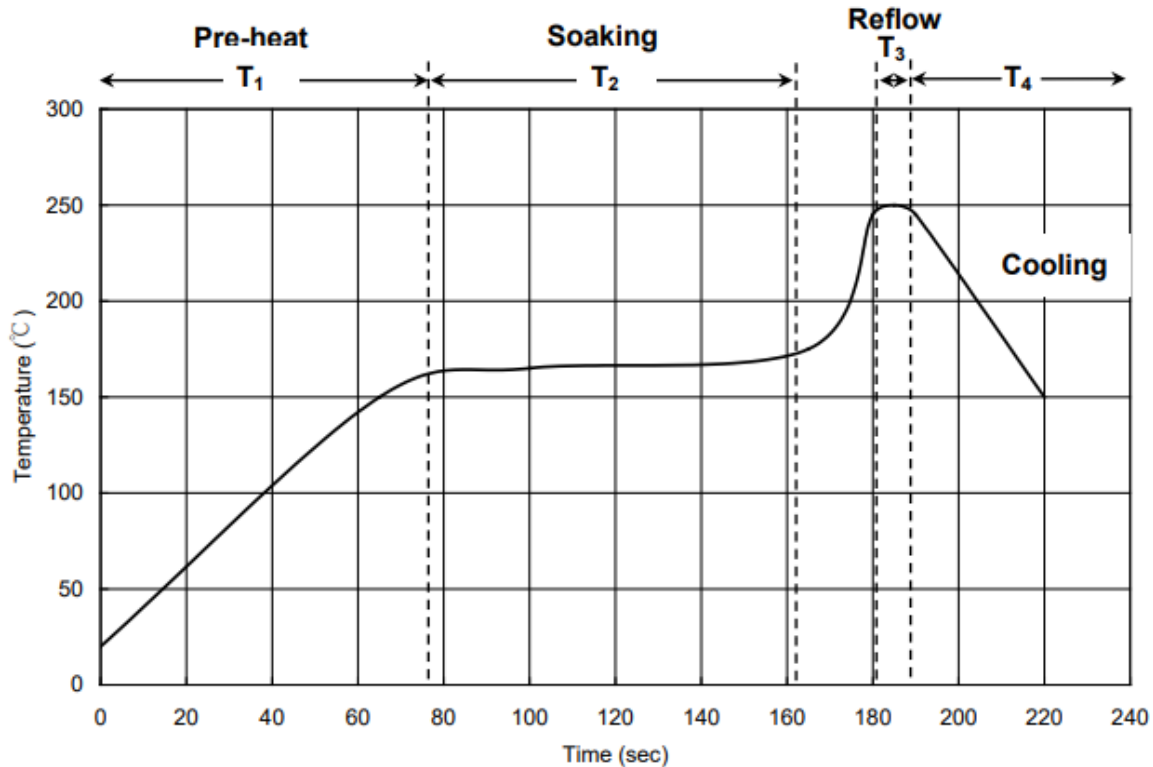

	Parameter	Values
T1	Ramp Up Rate	1.0 ~ 3.0 °C/sec
	Pre-heat Time	50 ~ 80 sec
T2	Soaking Temperature	155 ~ 185 °C
	Dwell Time During Soaking	60 ~ 120 sec
T3	Reflow Temperature	240 ~ 250 °C
	Reflow Time	Max 10 sec
	Ramp Up Rate During Reflow	1.2 ~ 2.3 °C/sec
T4	Cooling	1.0 ~ 6.0 °C/sec

Suggest using Sn96Ag3Cu 0.5 lead free solder.

Cleaning: Use alcohol – based cleaning solvents such as isopropyl alcohol to clean the LED if necessary.



# American Opto Plus LED Corp.

## IRP4-850C-45D

3.9 x 3.9 x 2.9mm High Power IR LED

### RECOMMENDED SOLDER PATTERN

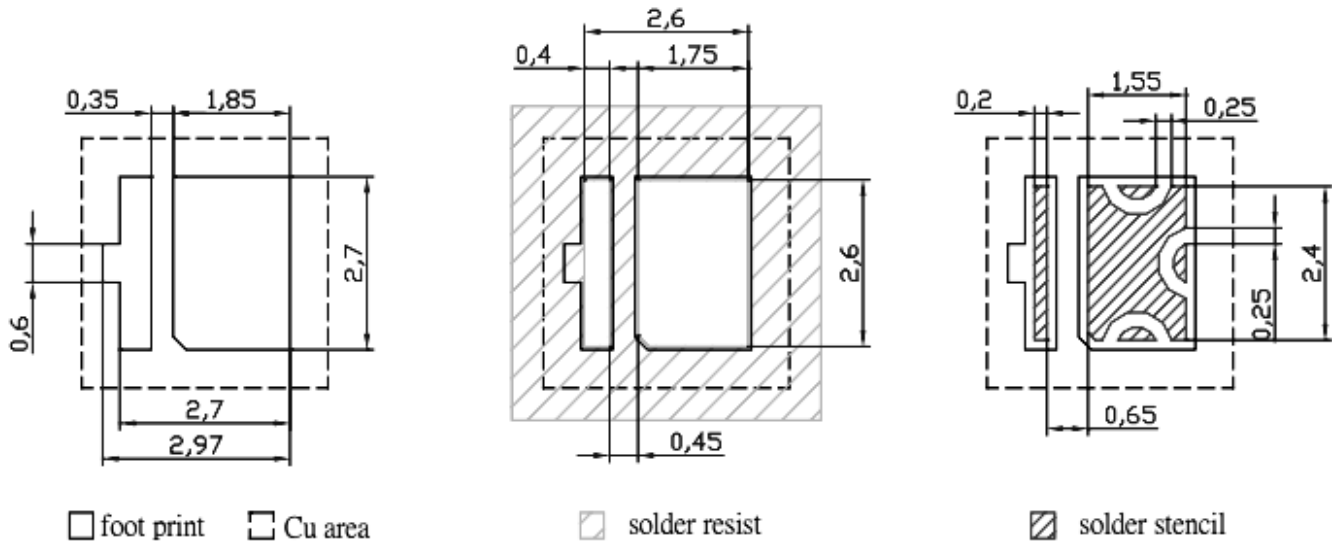

Note:

1. Units are in millimeters.
2. Tolerances are  $\pm 0.05$ .



# American Opto Plus LED Corp.

## IRP4-850C-45D

### 3.9 x 3.9 x 2.9mm High Power IR LED

#### HANDLING PRECAUTIONS



Do not poke the Led Lens with sharp object



Do not stack assembled PCB



Do not hold the Led with hand



Do not press or push the Led Lens

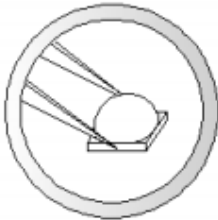

Hold the Led only by the substrate

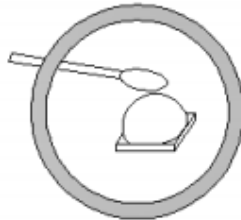

Clean the LED surface with cotton bud

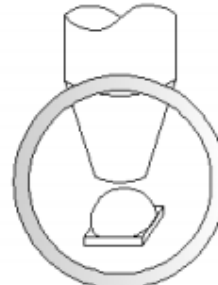

Use pick and place nozzle per recommendation in data sheet