

## Features

- High reliability LED package.
- Ideal for indication light on hand held products
- Long life and robust package
- Standard Package: 500pcs/ Reel
- MSL (Moisture Sensitivity Level): 2
- Halogen-free
- RoHS compliant



## Applications

- Backlighting for tell-tale indicators
- Dashboard lighting
- Interior lighting (footwell, dome light, accent lighting, etc.)
- Exterior lighting (turn signals, side markers, CHMSL, etc.)
- Signs and signals
- Various applications requiring high temperature rating



**ATTENTION**  
OBSERVE PRECAUTIONS  
FOR HANDLING  
ELECTROSTATIC  
DISCHARGE  
SENSITIVE  
DEVICES

## Package Dimensions

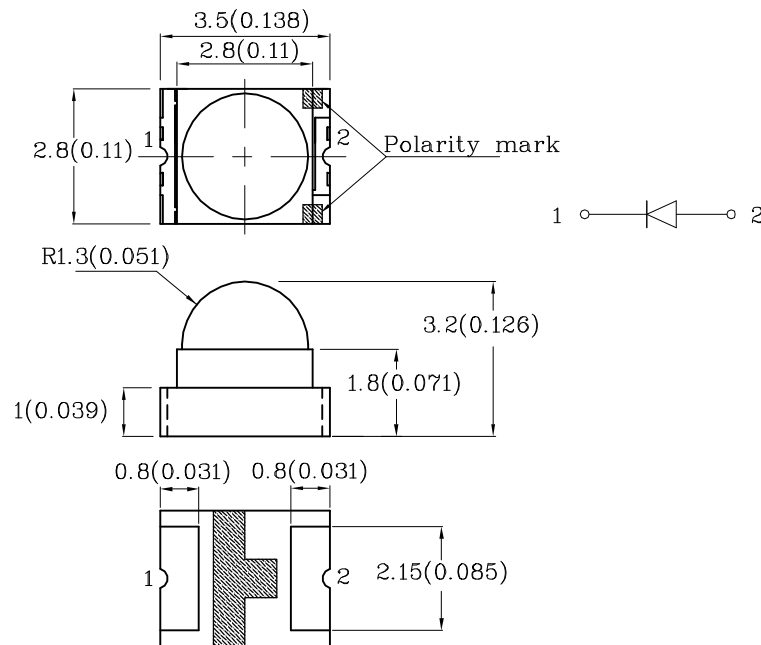

### Notes:

1. All dimensions are in millimeters (inches).
2. Tolerance is  $\pm 0.2(0.008)$  unless otherwise noted.
3. Specifications are subject to change without notice.

Part Number	Emitting Color	Emitting Material	Lens-color	Luminous Intensity CIE127-2007* (IF=2mA) mcd			Viewing Angle 2θ 1/2
				Code.	Min.	Max.	
XZCM2ACY45W-2HTA	Yellow	AlGaInP	Water Clear	VA*	80*	100*	40°
				VB*	100*	120*	
				WA*	120*	150*	
				WB*	150*	180*	
				XA*	180*	215*	
				XB*	215*	250*	

Note:

1.01/2 is the angle from optical centerline where the luminous intensity is 1/2 of the optical peak value.

\*Luminous intensity value is in accordance with CIE127-2007 standards.

### Absolute Maximum Ratings at Ta=25°C

Parameter	Symbol	Value	Unit
Power dissipation	P <sub>D</sub>	75	mW
Junction temperature	T <sub>J</sub>	115	°C
Reverse Voltage	V <sub>R</sub>	5	V
Operating Temperature	T <sub>op</sub>	-40 To +100	°C
Storage Temperature	T <sub>stg</sub>	-40 To +115	°C
DC Forward Current	I <sub>F</sub>	30	mA
Peak Forward Current [2]	I <sub>FM</sub>	140	mA
Electrostatic Discharge Threshold (HBM)		3000	V
Thermal Resistance (Junction/ambient) [1]	R <sub>th j-a</sub>	740	°C/W
Thermal Resistance (Junction / Solder point) [1]	R <sub>th j-s</sub>	600	°C/W

Notes:

1. R<sub>th(j-a)</sub> Results from mounting on PC board FR4 (pad size≥16 mm<sup>2</sup> per pad),

2. 1/10 Duty Cycle, 0.1ms Pulse Width.

3. A Relative Humidity between 40% and 60% is recommended in ESD-protected work areas to reduce static build up during assembly process

(Reference JEDEC/JESD625-A and JEDEC/J-STD-033)

### Electrical / Optical Characteristics at Ta=25°C

Parameter	Symbol	Value				Unit
		Code.	Min.	Typ.	Max.	
Wavelength at peak emission CIE127-2007* I <sub>F</sub> = 2mA	λ <sub>peak</sub>		-	590*		nm
Dominant Wavelength CIE127-2007* I <sub>F</sub> = 2mA	λ <sub>dom</sub> [1]	3*	586*	-	588*	nm
		4*	588*	-	590*	
		5*	590*	-	592*	
Spectral bandwidth at 50% F <sub>REL MAX</sub> I <sub>F</sub> = 2mA	Δλ	-	-	20		nm
Forward Voltage I <sub>F</sub> = 2mA	V <sub>F</sub> [2]	-	-	1.85	2.2	V
Reverse Current V <sub>R</sub> = 5V	I <sub>R</sub>	-	-	-	10	μA
Temperature coefficient of λ <sub>peak</sub> I <sub>F</sub> = 2mA, -10°C ≤ T ≤ 100°C	TC λ <sub>peak</sub>	-	-	0.12	-	nm/°C
Temperature coefficient of λ <sub>dom</sub> I <sub>F</sub> = 2mA, -10°C ≤ T ≤ 100°C	TC λ <sub>dom</sub>	-	-	0.07	-	nm/°C
Temperature coefficient of V <sub>F</sub> I <sub>F</sub> = 2mA, -10°C ≤ T ≤ 100°C	TC <sub>V</sub>	-	-	-2.0	-	mV/°C

Notes:

1. Wavelength : + / -1nm.

2. Forward Voltage: +/-0.1V.

\* Wavelength value is in accordance with CIE127-2007 standards.

Dec 13,2019

XDSB9290 V2-Z Layout: Maggie L.

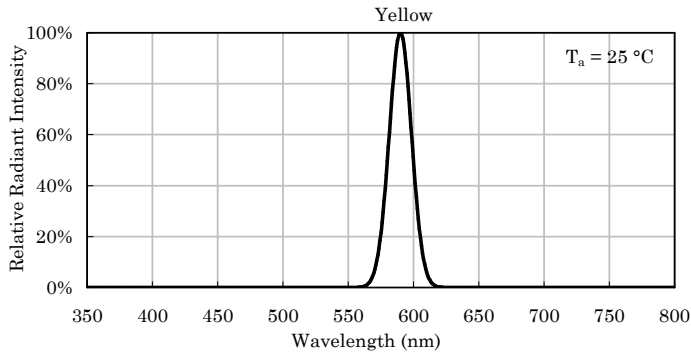

Relative Intensity Vs. CIE Wavelength

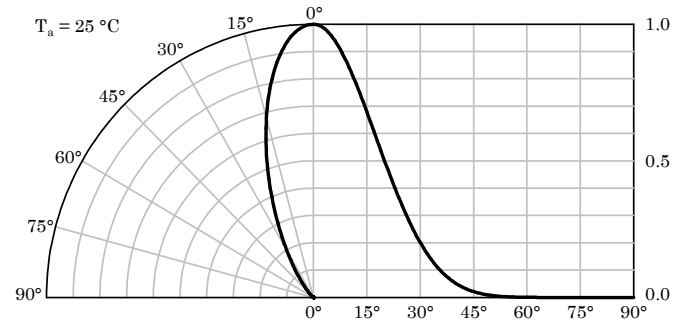

Spatial Distribution

❖ **Yellow**

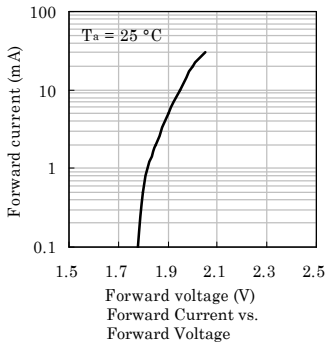

Forward Current vs. Forward Voltage

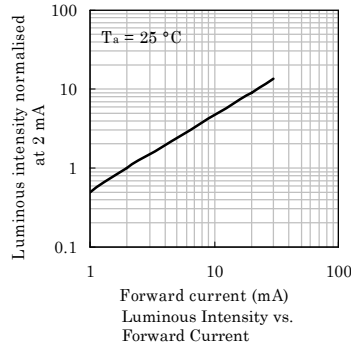

Luminous Intensity vs. Forward Current

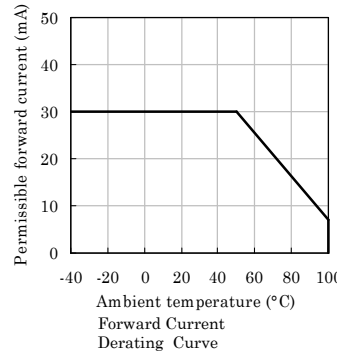

Forward Current Derating Curve

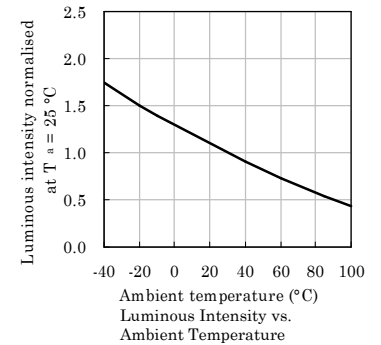

Luminous Intensity vs. Ambient Temperature

**LED is recommended for reflow soldering and soldering profile is shown below.**

Reflow Soldering Profile for SMD Products (Pb-Free Components)

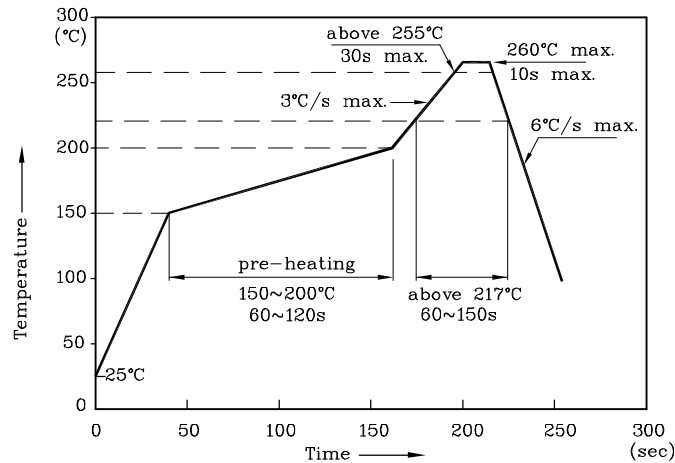

Notes:

1. All temperatures refer to the center of the package, measured on the package body surface facing up during reflow.
2. Do not apply any stress to the LED during high temperature conditions.
3. Maximum number of soldering passes: 2

- ❖ The device has a single mounting surface.  
The device must be mounted according to the specifications.

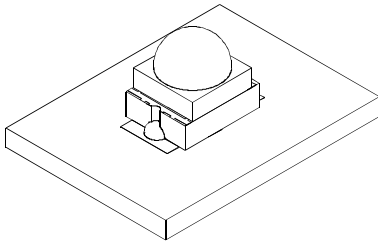

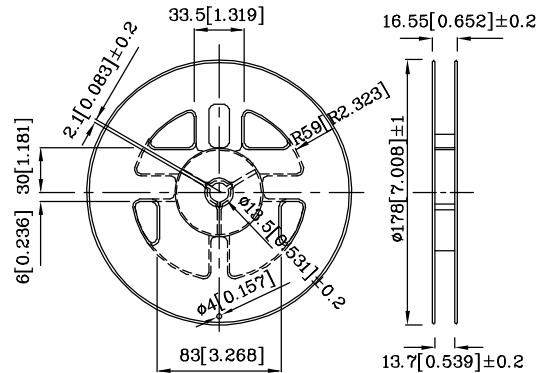

### Reel Dimension

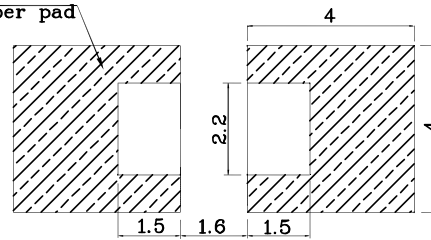

### Recommended Soldering Pattern (Units : mm; Tolerance: ±0.1)

Pad design for improved heat dissipation Cu-area > 16mm<sup>2</sup> per pad



 Solder resist

### ❖ Tape Specification (Units : mm)

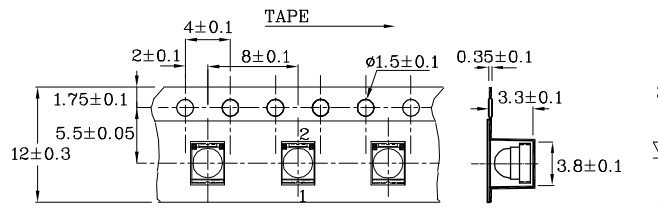

#### Remarks:

If special sorting is required (e.g. binning based on forward voltage, Luminous intensity / luminous flux, or wavelength), the typical accuracy of the sorting process is as follows:

1. Wavelength: +/- 1nm
2. Luminous intensity / luminous flux: +/- 15%
3. Forward Voltage: +/- 0.1V

Note: Accuracy may depend on the sorting parameters.

**PACKING & LABEL SPECIFICATIONS**

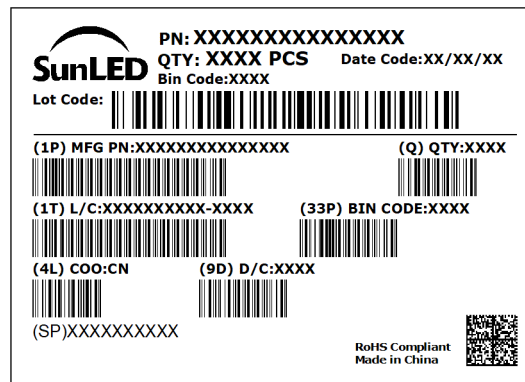
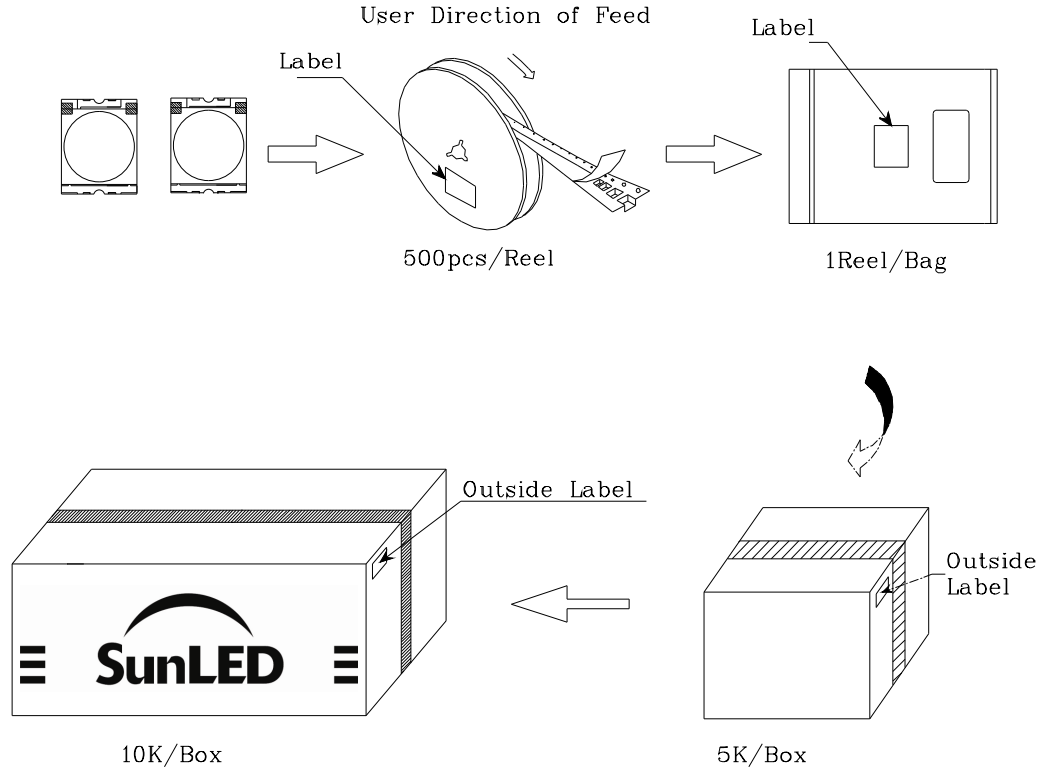

**TERMS OF USE**

1. Data presented in this document reflect statistical figures and should be treated as technical reference only.
2. Contents within this document are subject to improvement and enhancement changes without notice.
3. The product(s) in this document are designed to be operated within the electrical and environmental specifications indicated on the datasheet. User accepts full risk and responsibility when operating the product(s) beyond their intended specifications.
4. The product(s) described in this document are intended for electronic applications in which a person's life is not reliant upon the LED. Please consult with a SunLED representative for special applications where the LED may have a direct impact on a person's life.
5. The contents within this document may not be altered without prior consent by SunLED.
6. Additional technical notes are available at <https://www.SunLEDusa.com/TechnicalNotes.asp>

### Reliability Test Items And Conditions

The reliability of products shall be satisfied with items listed below

**Lot Tolerance Percent Defective (LTPD) : 10%**

No.	Test Item	Standards	Test Condition	Test Times / Cycles	Number of Damaged
1	Continuous operating test	-	$T_a = 25^{\circ}\text{C}$ , $I_F =$ maximum rated current *	1,000 h	0 / 22
2	High Temp. operating test	EIAJ ED-4701/100 (101)	$T_a = 100^{\circ}\text{C}$ , $I_F =$ maximum rated current *	1,000 h	0 / 22
3	Low Temp. operating test	-	$T_a = -40^{\circ}\text{C}$ , $I_F =$ maximum rated current *	1,000 h	0 / 22
4	High temp. storage test	EIAJ ED-4701/100 (201)	$T_a =$ maximum rated storage temperature	1,000 h	0 / 22
5	Low temp. storage test	EIAJ ED-4701/100 (202)	$T_a = -40^{\circ}\text{C}$	1,000 h	0 / 22
6	High temp. & humidity storage test	EIAJ ED-4701/100 (103)	$T_a = 60^{\circ}\text{C}$ , RH = 90%	1,000 h	0 / 22
7	High temp. & humidity operating test	EIAJ ED-4701/100 (102)	$T_a = 60^{\circ}\text{C}$ , RH = 90% $I_F =$ maximum rated current *	1,000 h	0 / 22
8	Soldering reliability test	EIAJ ED-4701/100 (301)	Moisture soak: $30^{\circ}\text{C}$ , 70% RH, 72h Preheat: $150\sim 180^{\circ}\text{C}$ (120s max.) Soldering temp: $260^{\circ}\text{C}$ (10s)	2 times	0 / 18
9	Thermal shock operating test	-	$T_a = -40^{\circ}\text{C}$ (15min) ~ $100^{\circ}\text{C}$ (15min) $I_F =$ derated current at $100^{\circ}\text{C}$	1,000 cycles	0 / 22
10	Thermal shock test	-	$T_a = -40^{\circ}\text{C}$ (15min) ~ maximum rated Storage temperature(15min)	1,000 cycles	0 / 22
11	Electric Static Discharge (ESD)	EIAJ ED-4701/100 (304)	$C = 100\text{pF}$ , $R_2 = 1.5\text{K}\Omega$ $V = 3000\text{V}$	Once each Polarity	0 / 22
12	Vibration test	-	$a = 196\text{m/s}^2$ , $f = 100\sim 2\text{KHz}$ , $t = 48\text{min}$ for all xyz axes	4 times	0 / 22

\* : Refer to forward current vs. derating curve diagram

### Criteria for Judging Damage

Items	Symbols	Conditions	Failure Criteria
luminous Intensity	$I_v$	$I_F = 2\text{mA}$	Testing Min. Value < Spec.Min.Value x 0.5
Forward Voltage	$V_F$	$I_F = 2\text{mA}$	Testing Max. Value $\geq$ Spec.Max.Value x 1.2
Reverse Current	$I_R$	$V_R =$ Maximum Rated Reverse Voltage	Testing Max. Value $\geq$ Spec.Max.Value x 2.5
High temp. storage test	-	-	Occurrence of notable decoloration, deformation and cracking